

DS-2SE4C425MWG-4G/14 TandemVu 4 MP 25 × IR Network Speed Dome



Hikvision DS-2SE4C425MWG-E(14F0) 4 MP 25 × IR Network Speed Dome adopts 1/2.8" progressive scan CMOS chip. With the 15 × optical zoom lens, the camera offers more details over expansive areas. This series of cameras can be widely used for wide ranges of high-definition, such as rivers, roads, railways, airports, squares, parks, scenic spots, and venues, etc.

- Captures a large area and great details at the same time
- High quality imaging with 4 MP resolution
- Focuses on human and vehicle targets classification based on deep learning
- Excellent low-light performance with powered-by-DarkFighter technology and ColorVu technology
- Secures an expansive area with 25 × optical zoom and 16 × digital zoom
- Expansive night view with up to 100 m IR distance & 30 m white light
- Build-in speaker and dual-microphone for real-time high quality audio security
- Active strobe light and audio alarm to warn intruders off
- Supports 12 VDC & PoE+

▪ Specification

Camera	
Image Sensor	[Bullet channel] 1/2.8" Progressive Scan CMOS, [PTZ channel] 1/2.8" Progressive Scan CMOS
Max. Resolution	[Bullet channel] 2560 × 1440, [PTZ channel] 2560 × 1440
Min. Illumination	[Bullet channel]: 0.0005 Lux @ (F1.0, AGC ON), 0 Lux with light; [PTZ channel]: Color: 0.005 Lux @ (F1.6, AGC ON), B/W: 0.001 Lux @ (F1.6, AGC ON), 0 Lux with IR
Shutter Speed	1 s to 1/30,000 s
Day & Night	ICR
Zoom	[PTZ channel] 25 × optical, 16 × digital
Slow Shutter	yes
Lens	
Focal Length	[Bullet channel] 2.8 mm, [PTZ channel] 5 to 125 mm
FOV	[Bullet channel] horizontal field of view: 96.1°, vertical field of view: 52.1°, diagonal field of view: 113.3°, [PTZ channel] horizontal field of view: 55° to 2.4°, vertical field of view: 33° to 1.4°, diagonal field of view: 61.5° to 2.8°
Focus	auto,manual,semi-auto
Aperture	[Bullet channel]: F1.0; [PTZ channel]: F1.6
Zoom Speed	[PTZ channel]: approx. 2.3 s
Illuminator	
Supplement Light Type	[PTZ channel]: IR; [Bullet channel]: White Light
Supplement Light Range	[PTZ channel]: up to 100 m; [Bullet channel]: up to 30 m
Smart Supplement Light	Yes
PTZ	
Movement Range (Pan)	360° endless
Movement Range (Tilt)	[Bullet channel] 9° to 21° (manually adjust), [PTZ channel] -15° to 90°
Pan Speed	Pan speed: configurable from 0.1° to 80°/s, preset speed: 80°/s
Tilt Speed	Tilt speed: configurable from 0.1° to 80°/s, preset speed 80°/s
Proportional Pan	yes
Presets	300
Preset Freezing	yes
Patrol Scan	8 patrols, up to 32 presets for each patrol
Pattern Scan	4 pattern scans
Park Action	preset,frame scan,tilt scan,patrol scan,random scan,auto scan,pattern scan,panorama scan
3D Positioning	yes
PTZ Status Display	yes
Scheduled Task	Preset,pattern scan,patrol scan,tilt scan,auto scan,random scan,frame scan,panorama scan,dome reboot,dome adjust,aux output
Power-off Memory	yes
Video	
Main Stream	[Bullet channel] 50 Hz: 25 fps (2560 × 1440, 1920 × 1080, 1280 × 960, 1280 × 720), 60 Hz: 30 fps (2560 × 1440, 1920 × 1080, 1280 × 960, 1280 × 720),[PTZ channel] 50 Hz: 25 fps (2560 × 1440, 1920 × 1080, 1280 × 960, 1280 × 720), 60 Hz: 30 fps (2560 × 1440, 1920 × 1080, 1280 × 960, 1280 × 720)

Sub-Stream	[Bullet channel]: 50 Hz: 25 fps (704 × 576, 640 × 480, 352 × 288) 60 Hz: 30 fps (704 × 480, 640 × 480, 352 × 240) [PTZ channel]: 50 Hz: 25 fps (704 × 576, 640 × 480, 352 × 288) 60 Hz: 30 fps (704 × 480, 640 × 480, 352 × 240)
Third Stream	[Bullet channel]: 50 Hz: 25 fps (1920 × 1080, 1280 × 960, 1280 × 720, 704 × 576, 640 × 480, 352 × 288) 60 Hz: 30 fps (1920 × 1080, 1280 × 960, 1280 × 720, 704 × 480, 640 × 480, 352 × 240) [PTZ channel]: 50 Hz: 25 fps (1920 × 1080, 1280 × 960, 1280 × 720, 704 × 576, 640 × 480, 352 × 288) 60 Hz: 30 fps (1920 × 1080, 1280 × 960, 1280 × 720, 704 × 480, 640 × 480, 352 × 240)
Video Compression	H.265,H.264,MJPEG
Video Bit Rate	32 kbps to 16384 kbps
H.264 Type	main profile,baseline profile,high profile
H.265 Type	main profile
Scalable Video Coding (SVC)	yes
Region of Interest (ROI)	8 fixed regions for each stream
Audio	
Audio Compression	G.711,G.722.1,G.726,MP2L2,PCM,MP3,AAC-LC
Audio Bit Rate	64 Kbps (G.711),16 Kbps (G.722.1),16 Kbps (G.726),32 to 192 Kbps (MP2L2),16 to 64Kbps (AAC-LC),8 to 320 Kbps (MP3)
Audio Sampling Rate	MP2L2: 16 kHz, 32kHz, 48 kHz,AAC-LC: 16 kHz, 32kHz, 48 kHz,PCM: 8 kHz, 16 kHz, 32kHz, 48 kHz,MP3: 8 kHz, 16 kHz, 32kHz, 48 kHz
Environment Noise Filtering	yes
Network	
Protocols	DHCP,FTP,HTTPS,TCP/IP,ICMP,HTTP,SFTP,DNS,DDNS,RTP,RTSP,RTCP,PPPoE,NTP,UPnP,SMTP,SNMP,IGMP,802.1X,QoS,IPv4/IPv6,UDP,Bonjour,WebSocket,WebSockets
Simultaneous Live View	20
API	ONVIF (Profile S, Profile G, Profile T),ISAPI,SDK,ISUP
User/Host	32
Security	802.1X authenticated access,MAC address binding,Authenticated username and password,IP address filter,HTTPS encryption
Network Storage	NAS (NFS, SMB/CIFS),auto network replenishment (ANR)
Client	iVMS-4200,HikCentral Pro,Hik-Connect
Web Browser	IE 11, Chrome 80+, Firefox 80+, Safari 13+
Wireless (Mobile Communication)	
Mobile Communication Type	4G
Frequency	LTE-FDD:B1/B3/B8/B11/B18/B19/B21/B26/B28; LTE-TDD:B41; WCDMA:B1/B8; WCDMA:B1/B2/B3/B4/B5/B8; GSM:B2/B3/B5/B8; WCDMA:B1/B5/B8; GSM:B3/B5/B8
Standard	LTE-FDD/LTE-TDD/WCDMA

Image	
Image Parameters Switch	Yes
Image Settings	sharpness,saturation,brightness,contrast
Day/Night Switch	day, night, auto, scheduled-switch
Wide Dynamic Range (WDR)	120 dB WDR
SNR	> 52dB
Defog	Digital defog
Image Stabilization	EIS
Image Enhancement	BLC,HLC,3D DNR
Privacy Mask	[Bullet channel] 8 programmable polygon privacy masks, [PTZ channel] 24 programmable polygon privacy masks; mask color or mosaic configurable
Regional Focus	yes
Regional Exposure	yes
Interface	
Ethernet Interface	RJ45, self-adaptive 10M/100M Ethernet port
On-board Storage	Built-in memory card slot, support microSD/microSDHC/microSDXC card, up to 512 GB
Audio	1 audio input, 2.0 to 2.4Vp-p, 1k Ohm±10%, 1 audio output, line level, impedance: 600 Ω
Alarm	1 alarm input, 1 alarm output
Reset	yes
Built-in Microphone	2 built-in microphones,picking up sounds in the radius up to 8 meters
Built-in Speaker	with effective distance reaching max. 8 meters,1 built-in speaker
Event	
Basic Event	Motion detection,video tampering alarm,exception (network disconnected, IP address conflict, illegal login, HDD full, HDD error),alarm input and output,audio exception detection
Smart Event	audio exception detection,region exiting detection,region entrance detection,intrusion detection,Line crossing detection
Linkage	[Bullet channel] Upload to FTP/NAS/memory card, notify surveillance center, send email, trigger alarm output, and trigger recording,[PTZ channel] Upload to FTP/NAS/memory card, notify surveillance center, send email, trigger alarm output, trigger recording, strobe light and audio alarm, and PTZ actions (such as preset, patrol scan, pattern scan)
Deep Learning Function	
Face Capture	Detects up to 5 faces simultaneously, Uploads face with background and closed-up face pictures,Supports detecting, tracking, capturing, grading, selecting of face in motion, and outputs the best face picture
Regional People Counting	Supports up to 8 detection regions, and independent arming schedule and linkage method. Supports 3 detection modes: people density detection, number of people exception detection, waiting time exception detection
Linkage and Tracking	
Smart Linkage	manual tracking, linked tracking capture
General	
Power	12 VDC, PoE+
Dimension	∅166 mm × 294.8 mm (∅6.5" × 11.6")

Weight	Approx. 3.0 kg (16.5 lb.)
Material	ADC12
Operating Condition	-30 °C to 65 °C (-22 °F to 149 °F). Humidity 95% or less (non-condensing)
General Function	mirror, password protection, watermark, IP address filter
Demist	Demist by heating the glass
Approval	
Protection	IP67 (IEC 60529-2013),TVS 6000 V lightning protection, surge protection and voltage transient protection

▪ DORI

The DORI (detect, observe, recognize, identify) distance gives the general idea of the camera ability to distinguish persons or objects within its field of view. It is calculated based on the camera sensor specification and the criteria given by EN 62676-4: 2015.

DORI	Detect	Observe	Recognize	Identify
Definition	25 px/m	63 px/m	125 px/m	250 px/m
Distance (Tele)	960.0 m (3149.61 ft)	381.0 m (1250.0 ft)	192.0 m (629.92 ft)	96.0 m (314.96 ft)

▪ Available Model

DS-2SE4C425MWG-4G/14(F0)

DS-2SE4C425MWG-4G/14(F0)/JP

DS-2SE4C425MWG-4G/14(F0)/LA

▪ Dimension

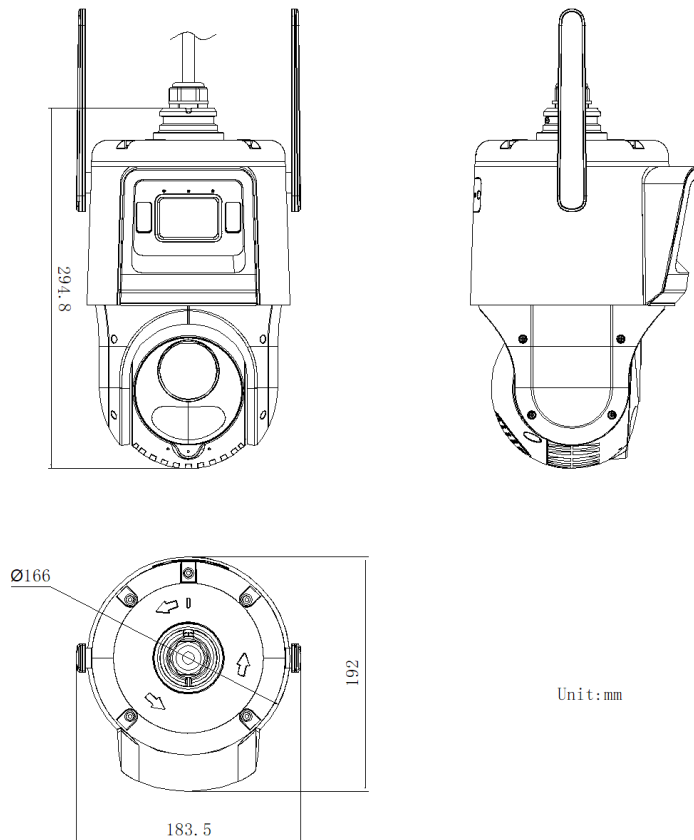





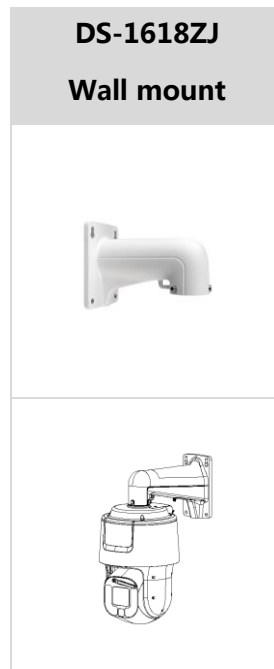







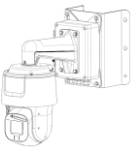
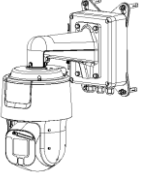

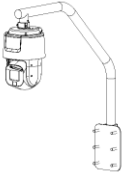











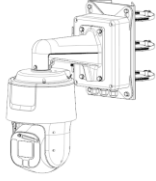
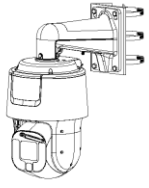

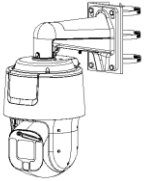

▪ Accessory

▪ **Included**

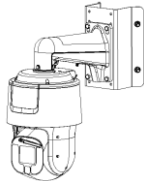

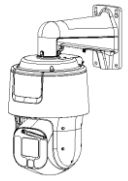
▪ **Optional**

DS-1604ZJ-BOX-CO RNER Wall mount	DS-1604ZJ-box Wall mount	DS-1604ZJ Wall mount	DS-1660ZJ Wall mount	DS-1661ZJ Pendant Mount
				
				
DS-1662ZJ Pendant Mount	DS-1667ZJ Pendant Mount	DS-1673ZJ Horizontal pole mount	DS-1604ZJ-BOX-PO LE Vertical pole mount	DS-1684ZJ Vertical pole mount
				

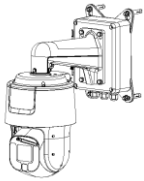
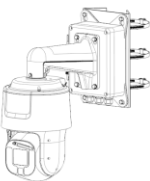
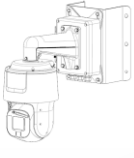
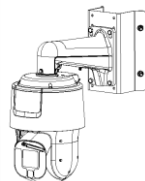
				
DS-1604ZJ-pole Vertical pole mount	DS-1663ZJ In-ceiling mount	DS-1604ZJ-corner Corner mount	DS-1619ZJ Others	DS-1602ZJ Wall mount
				
				
DS-1674ZJ Junction box	DS-4650ZJ-WC Vertical pole mount	DS-4660ZJ-WC Corner mount	DS-1276ZJ Corner mount	
				
				

See Far, Go Further



www.hikvision.com
support@hikvision.com

